

ASBS.../LED

3 + PE

Steckbarer Aktor-/Sensor-Verteiler mit LED-Betriebs- und Funktionsanzeige, 4-, 6- und 8-fach, kombinierte FIXCON-/M12-Buchse, 4-polig, 1 Signal pro Buchse, Erdanschluss, M23-Steckverbindung für die Zuleitung

Pluggable actuator/sensor distribution box with LED operation and function indicators, 4, 6 and 8 ports, combined FIXCON/M12 socket, 4 poles, 1 signal per socket, earth connection, M23 connection for the control cable

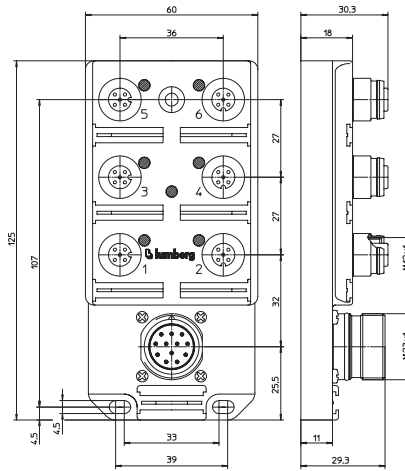
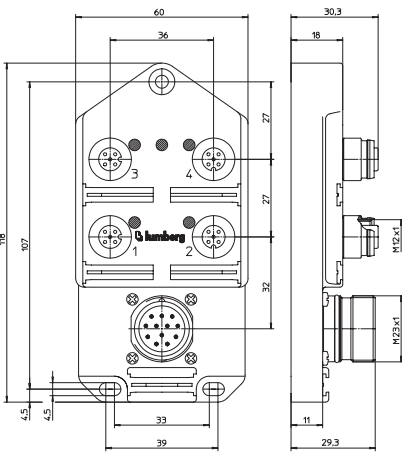
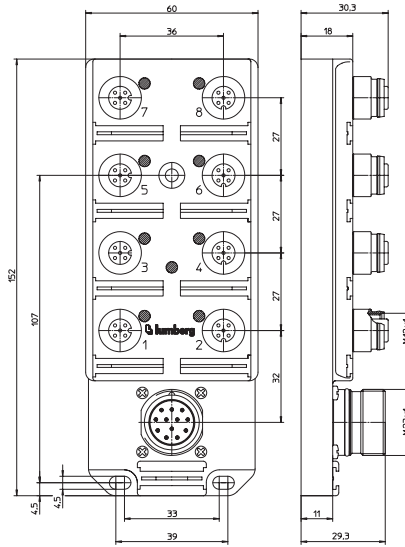

Pinbelegung / Schaltbild
Pin assignment / wiring diagram

4-fach
4 ports

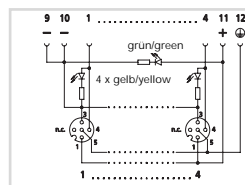

- 1 = 11 (+)
- 2 = n.c.
- 3 = 9 (-)
- 4 = 10 □
- 1 = 1 (1)
- 2 = 2 (2)
- 3 = 3 (3)
- 4 = 4 (4)
- 5 = 12 (PE)

6-fach
6 ports

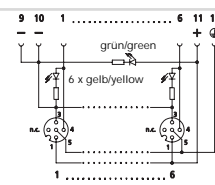

- 1 = 11 (+)
- 2 = n.c.
- 3 = 9 (-)
- 4 = 10 □
- 1 = 1 (1)
- 2 = 2 (2)
- 3 = 3 (3)
- 4 = 4 (4)
- 5 = 5 (5)
- 6 = 6 (6)
- 5 = 12 (PE)

8-fach
8 ports

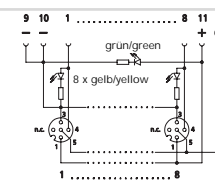



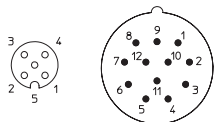





- 1 = 11 (+)
- 2 = n.c.
- 3 = 9 (-)
- 4 = 10 □
- 1 = 1 (1)
- 2 = 2 (2)
- 3 = 3 (3)
- 4 = 4 (4)
- 5 = 5 (5)
- 6 = 6 (6)
- 7 = 7 (7)
- 8 = 8 (8)
- 5 = 12 (PE)



Technische Daten	
Umgebungstemperatur	-15°C / +80°C
Werkstoffe	
Gehäuse / Griffkörper	TPU, selbstverlöschend
Kontaktträger	PA GF, selbstverlöschend
Kontakt	CuZn, unternickelt und 0,8 µm vergoldet
Gewindebuchse / Rändelschraube/-mutter / Sechskantschraube/-mutter / Hülse	CuZn, vernickelt
O-Ring	FKM
Mechanische Daten	
Schutzart	IP 67 Nur im verriegelten oder verschraubten Zustand mit den dazugehörigen Gegenstücken oder Schutzkappen.
Elektrische Daten	
Durchgangswiderstand	≤ 5 mΩ
Nennstrom bei 40°C	4 A pro Steckplatz / 12 A max. gesamt
Nennspannung	10–30 V DC
Bemessungsspannung	32 V
Isolationswiderstand	> 10 ⁹ Ω
Verschmutzungsgrad	3
Zubehör (inkl.)	
ZVK	2 Schutzkappen für nicht belegte Kupplungsgehäuse
ZBS	10 Beschriftungsschilder

Technical data	
Operating temperature range	-15°C / +80°C
Materials	
Housing / Molded body	TPU, self-extinguishing
Insert	PA GF, self-extinguishing
Contact	CuZn, pre-nickelated and 0.8 microns gold-plated
Receptacle shell / knurled screw/nut / hexagon screw/nut / sleeve	CuZn, nickel-plated
O-ring	FKM
Mechanical data	
Degree of protection	IP 67 Only in locked position with its proper counterparts or dust covers.
Electrical data	
Contact resistance	≤ 5 mΩ
Nominal current at 40°C	4 A per outlet / 12 A max. total
Nominal voltage	10–30 V DC
Rated voltage	32 V
Insulation resistance	> 10 ⁹ Ω
Pollution degree	3
Accessories (incl.)	
ZVK	2 dust covers for unused sockets
ZBS	10 attachable labels

Bestellbezeichnung Designation	Ausführung Version	
ASBS 4/LED 5-4	4-fach / 4 ports	  
ASBS 6/LED 5-4	6-fach / 6 ports	  
ASBS 8/LED 5-4	8-fach / 8 ports	  

Ein Einsatz der Produkte in aggressiven Medien ist im Einzelfall zu überprüfen.

The application of these products in harsh environments should always be checked before use.